

HSF

NOTES:

- MATERIAL SPECIFICATION:
 - HOUSING :PBT,UL94V-0,BLACK
 - TPA :PBT,UL94V-0,NATURAL
- ELECTRICAL PERFORMANCE:
 - INSULATION RESISTANCE:100MΩ Min
 - WITHSTANDING VOLTAGE:1000V AC
- OPERATING TEMPERATURE: -40°C to +100°C
- APPLICATION TERMINAL:72025-TC22SN01
- RoHS COMPLIANT

ORDERING INFORMATION

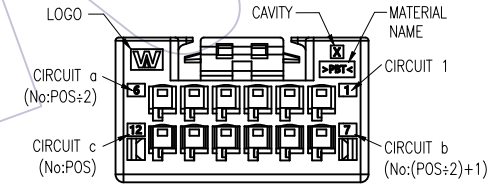
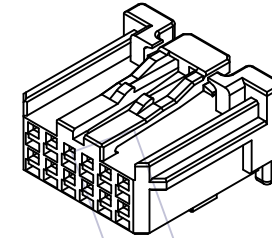
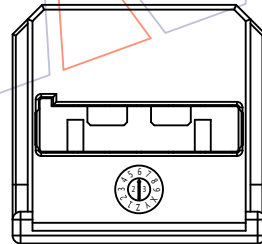
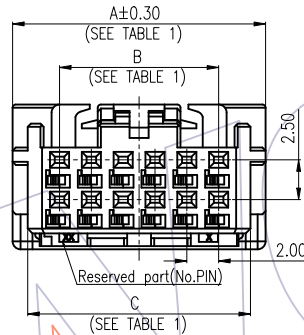
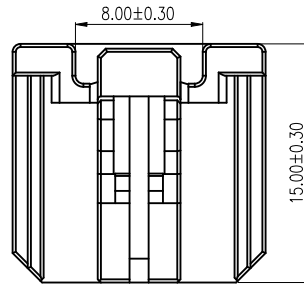
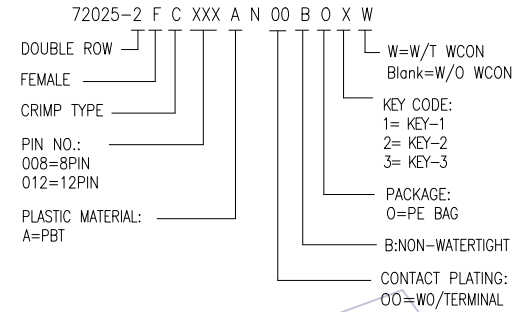
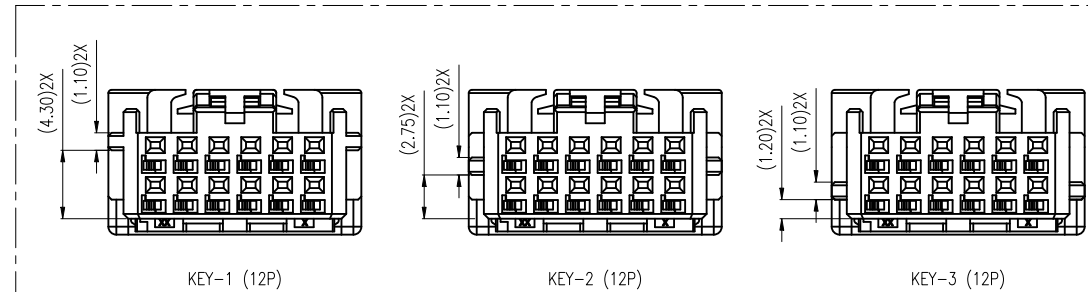

TABLE 1:

POS.	A	B	C
8	11.90	6.00	10.00
12	15.90	10.00	14.00



REV	DATE	MODIFICATION DESCRIPTION	CHANGE	OPERATION	DRAW	DATE	SCALE	PART NO.
A4	9/25'23	DETACH THE DIAGRAM	Joe.Xie	OPERATION	Joe.Xie	9/25'23	1:1	72025-2FCXXXAN00BOXW
A3	6/16'23	DETACH THE DIAGRAM	JINQUAN ZENG	X.X ±0.40	Joe.Xie	9/25'23	UNIT mm	TITLE: 2.0*2.5mm AUTO-CONN, DOUBLE ROW,FEMALE,CRIMP TYPE
A2	5/30'23	REGULATE THE DIAGRAM	JINQUAN ZENG	X.XX ±0.25	Tom.dai	DATE	SIZE A4	
A1	5/09'23	MODIFY THE APPEARANCE DIAGRAM	Joe.Xie	X.XXX ±0.15	Tom.dai	DATE	SHEET 1/4	CUSTOMER NO.
				ANGLE ± 3°	APPROVE	DATE	PROJ.	
				DIM TOL	Tom.dai			

WCON

Http: www.wcon.com

WCON-Dongguan Tel: +86 769 85358920 Fax: +86 769 85358915 E-mail: sales@wcon.com

WCON-Kunshan Tel: +86 512 57468408 Fax: +86 512 57468468 E-mail: salesks@wcon.com

HSF

NOTES:

- 1.MATERIAL SPECIFICATION:
 - 1-1.HOUSING :PBT,UL94V-0,BLACK
 - 1-2.TPA :PBT,UL94V-0,NATURAL
- 2.ELECTRICAL PERFORMANCE:
 - 2-1.INSULATION RESISTANCE:100MΩ Min
 - 2-2.WITHSTANDING VOLTAGE:1000V AC
- 3.OPERATING TEMPERATURE: -40°C to +100°C
- 4.APPLICATION TERMINAL:72025-TC22SNO1
- 5.RoHS COMPLIANT

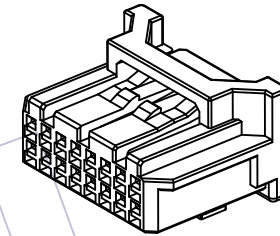
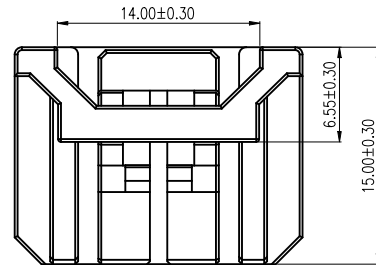

ORDERING INFORMATION

72025-2 F C XXX A N 00 B O X W

- DOUBLE ROW
- FEMALE
- CRIMP TYPE
- PIN NO.:
 - 016=16PIN 020=20PIN
 - 024=24PIN 028=28PIN
- PLASTIC MATERIAL:
 - A=PBT
- W=W/T WCON
- Blank=W/O WCON
- KEY CODE:
 - 1= KEY-1
 - 2= KEY-2
 - 3= KEY-3
- PACKAGE:
 - O=PE BAG
- B:NON-WATERTIGHT
- CONTACT PLATING:
 - OO=W0/TERMINAL

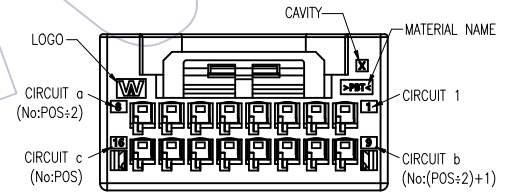
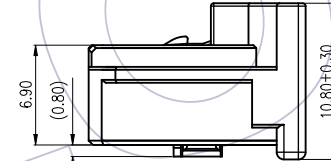
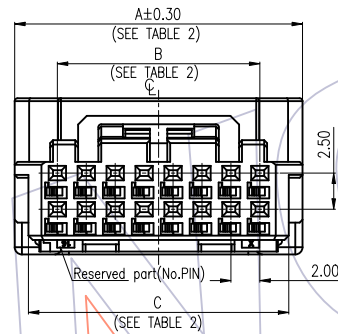
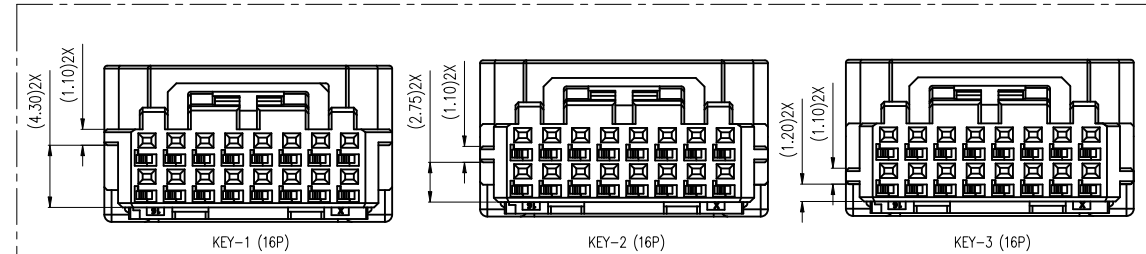
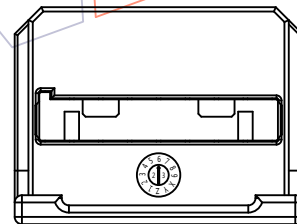

TABLE 2:

POS.	A	B	C
16	19.90	14.00	18.00
20	23.90	18.00	22.00
24	27.90	22.00	26.00
28	31.90	26.00	30.00



REV	DATE	MODIFICATION DESCRIPTION	CHANGE	OPERATION	DRAW	DATE	SCALE	PART NO.
A4	9/25'23	DETACH THE DIAGRAM	Joe.Xie	OPERATION	Joe.Xie	9/25'23	1:1	72025-2FCXXXAN00B0XW
A3	6/16'23	DETACH THE DIAGRAM	JINQUAN ZENG	X.X ±0.40	Joe.Xie	9/25'23	UNIT mm	TITLE: 2.0*2.5mm AUTO-CONN, DOUBLE ROW,FEMALE,CRIMP TYPE
A2	5/30'23	REGULATE THE DIAGRAM	JINQUAN ZENG	X.XX ±0.25	Tom.dai	DATE	SIZE A4	
A1	5/09'23	MODIFY THE APPEARANCE DIAGRAM	Joe.xie	X.XXX ±0.15	Tom.dai	DATE	SHEET 2/4	
REV	DATE	MODIFICATION DESCRIPTION	CHANGE	ANGLE ± 3°	APPROVE	DATE	SHEET 2/4	CUSTOMER NO.
				DIM TOL	Tom.dai		PROJ.	

WCON
Http: www.wcon.com

WCON-Dongguan Tel: +86 769 85358920 Fax: +86 769 85358915 E-mail: sales@wcon.com

WCON-Kunshan Tel: +86 512 57468408 Fax: +86 512 57468468 E-mail: salesks@wcon.com

HSF

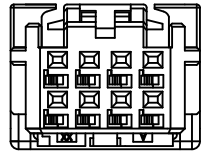

KEY-1 (8P)

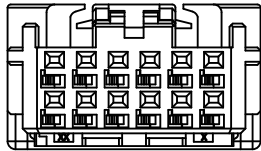

KEY-1 (12P)

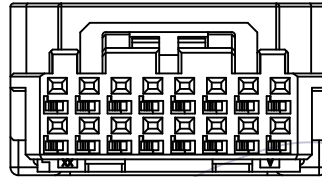

KEY-1 (16P)

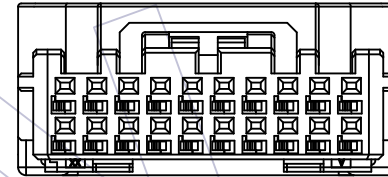

KEY-1 (20P)

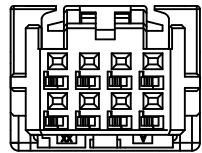

KEY-2 (8P)

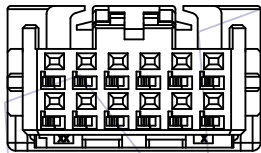

KEY-2 (12P)

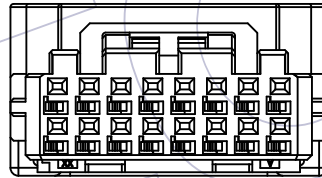

KEY-2 (16P)

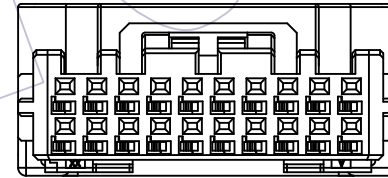

KEY-2 (20P)

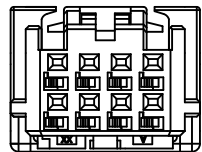

KEY-3 (8P)

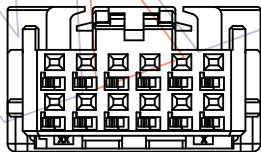

KEY-3 (12P)

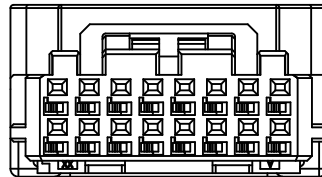

KEY-3 (16P)

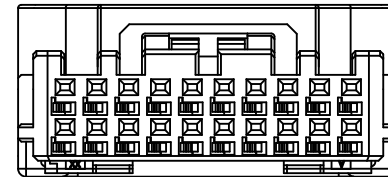

KEY-3 (20P)

A4	9/25'23	DETACH THE DIAGRAM	Joe.Xie	OPERATION	DRAW	DATE	SCALE	1:1	PART NO. 72025-2FCXXXAN00BOXW	 Http: www.wcon.com
A3	6/16'23	DETACH THE DIAGRAM	JINQUAN ZENG	X.X	Joe.Xie	9/25'23	UNIT	mm		
A2	5/30'23	REGULATE THE DIAGRAM	JINQUAN ZENG	X.XX	CHECK	DATE	SIZE	A4	TITLE: 2.0*2.5mm AUTO-CONN, DOUBLE ROW,FEMALE,CRIMP TYPE	WCON-Dongguan Tel: +86 769 85358920 Fax: +86 769 85358915 E-mail: sales@wcon.com
A1	5/09'23	MODIFY THE APPEARANCE DIAGRAM	Joe.xie	X.XXX	Tom.dai	DATE	SHEET	3/4		
REV	DATE	MODIFICATION DESCRIPTION	CHANGE	ANGLE	APPROVE	DATE	PROJ.	3/4	CUSTOMER NO.	WCON-Kunshan Tel: +86 512 57468408 Fax: +86 512 57468468 E-mail: salesks@wcon.com
				DIM	Tom.dai					

HSF

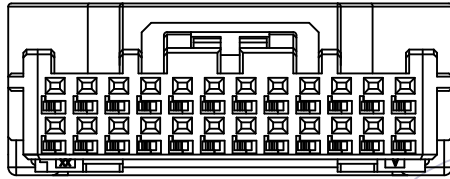

KEY-1 (24P)

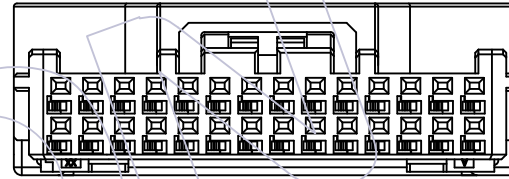

KEY-1 (28P)

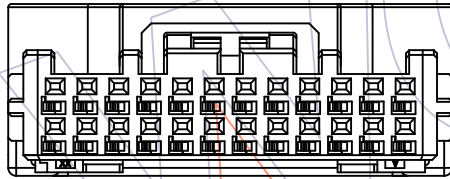

KEY-2 (24P)

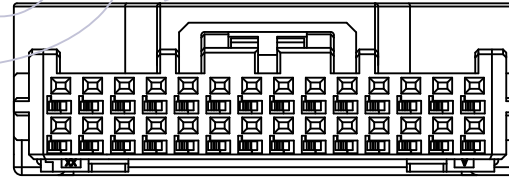

KEY-2 (28P)

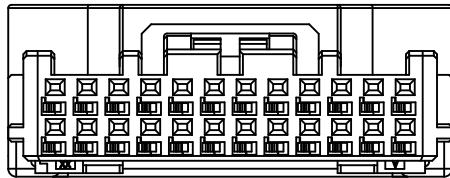

KEY-3 (24P)

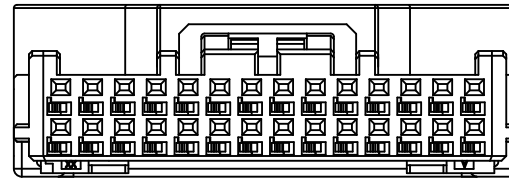

KEY-3 (28P)

A4	9/25'23	DETACH THE DIAGRAM	Joe.Xie	OPERATION	DRAW	DATE	SCALE	1:1	PART NO. 72025-2FCXXXAN00BOXW	
A3	6/16'23	DETACH THE DIAGRAM	JINQUAN ZENG	X.X	±0.40	Joe.Xie	9/25'23	UNIT		mm
A2	5/30'23	REGULATE THE DIAGRAM	JINQUAN ZENG	X.XX	±0.25	CHECK	DATE	SIZE	A4	TITLE: 2.0*2.5mm AUTO-CONN, DOUBLE ROW,FEMALE,CRIMP TYPE
A1	5/09'23	MODIFY THE APPEARANCE DIAGRAM	Joe.xie	X.XXX	±0.15	Tom.dai	DATE	SHEET	4/4	
REV	DATE	MODIFICATION DESCRIPTION	CHANGE	ANGLE	± 3°	APPROVE	DATE	PROJ.	⊕	CUSTOMER NO.
				DIM	TOL	Tom.dai				

WCON

Http: www.wcon.com

WCON-Dongguan	WCON-Kunshan
Tel: +86 769 85358920	Tel: +86 512 57468408
Fax: +86 769 85358915	Fax: +86 512 57468468
E-mail: sales@wcon.com	E-mail: salesks@wcon.com