

# HSF

Table.1: 6362-08MDHSXMCBA2 6362-08MUHSXMCBA2

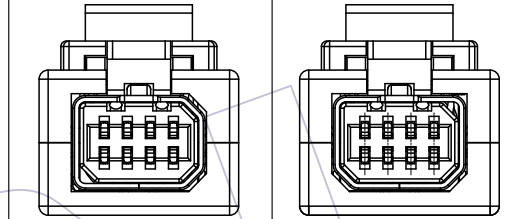
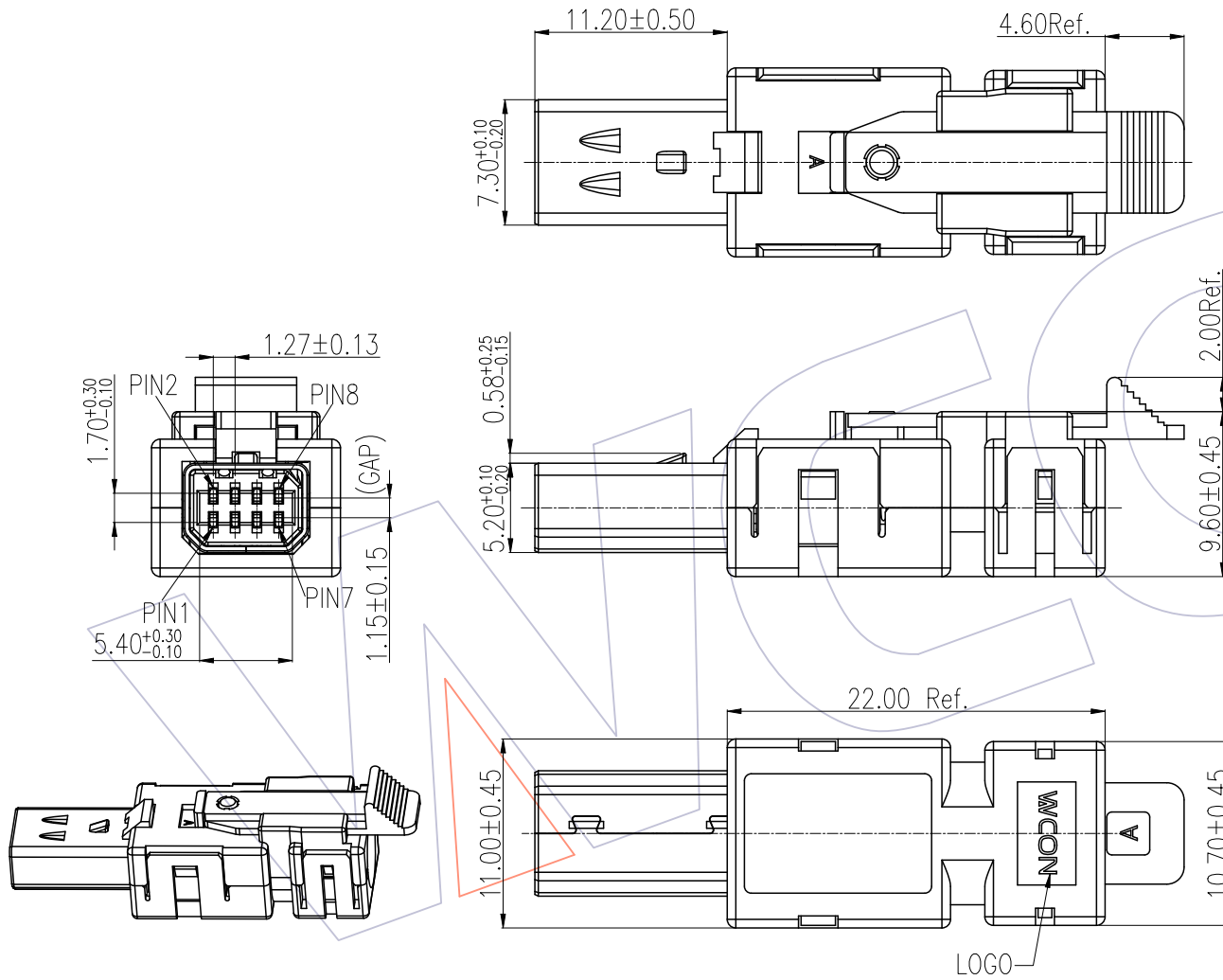

Item	Part Name	Part No.	Qty	Remark
①	Metal Bottom Cover	M6362-08MXMHXX01	1	SPCC,T=0.35,Plated Ni
②	Metal Top Cover	M6362-08MMHXX01	1	SPCC,T=0.35,Plated Ni
③	Plastic Top Cover	G6362-08MXHCBNX	1	ABS+PC,UL94V-0,Black
④	Plastic Bottom Cover	G6362-08MBHCBNX	1	ABS+PC,UL94V-0,Black
⑤	Connector Assemble	B6362-08MHSXAB1	1	C5191-H,T=0.30,Plated Au PBT,UL94V-0,Black
⑥	Cable Clamp	G6362-08MDHABN1	1	PA66,UL94V-0,Black
⑦	link rod	G6362-08MHHABN2	1	PBT,UL94V-0,Black
⑧	Long Push Rod	G6362-08MHHABN3	1	PBT,UL94V-0,Black

REV	DATE	MODIFICATION DESCRIPTION	CHANGE	OPERATION	DRAW	DATE	SCALE	Fit	PART NO.
A0	2022/05/10	NEW RELEASE	Jason	x.X ±0.40	Jason	2022/05/10	UNIT	mm	6362-08MXHSXMCBA2
				x.XX ±0.25	CHECK	DATE	SIZE	A4	TITLE:
				x.XXX ±0.15	Andrey		SHEET	1/3	1.27mm Micro I/O 8P Cable Assembly Connector Solder TYPE.Long Push Rod
				Angle ± 3°	APPROVE	DATE	PROJ.	⌀	Customer NO.
				DIM TOL					

## WCON

Http: www.wcon.com

WCON-Dongguan Tel: +86 769 85358920  
WCON-Kunshan Tel: +86 512 57468408  
Fax: +86 769 85358915 Fax: +86 512 57468468  
E-mail: sales@wcon.com E-mail: salesks@wcon.com

HSF

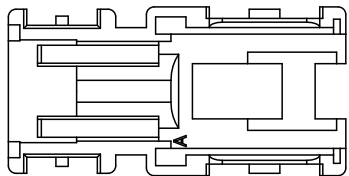
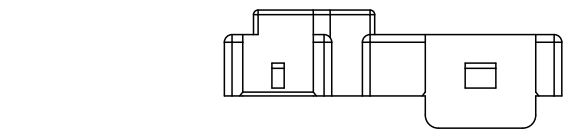

Plastic Top Cover

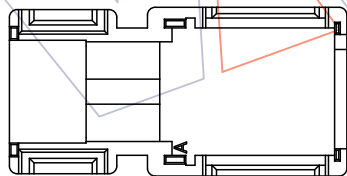
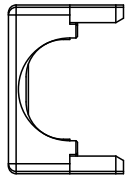
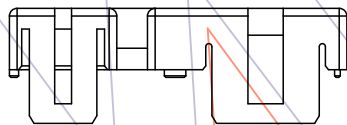
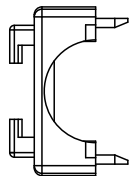

Plastic Bottom Cover

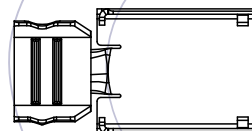
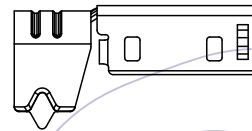

Metal Top Cover

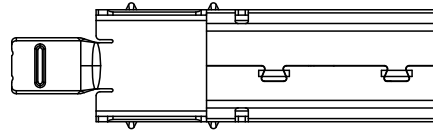
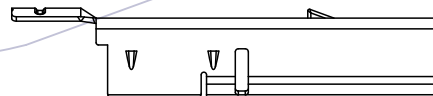
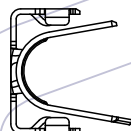

Metal Bottom Cover

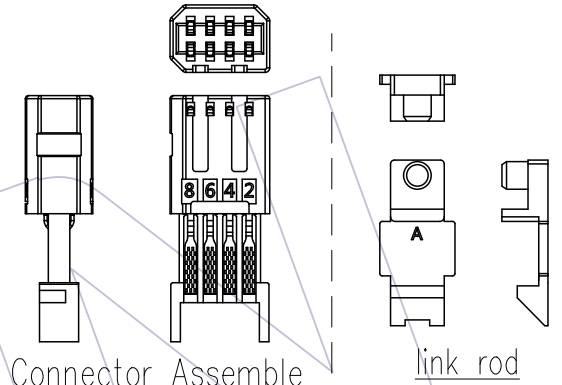
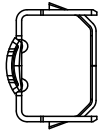

Connector Assembly

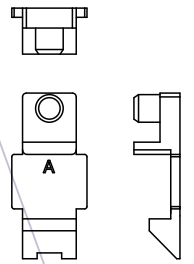

link rod

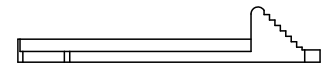

Long Push Rod

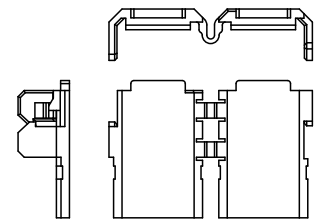
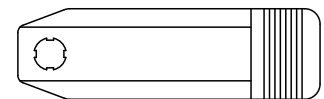

Cable Clamp

				OPERATION	DRAW	DATE	SCALE	Fit	PART NO.
				x.X ±0.40	Jason	2022/05/10	UNIT	mm	6362-08MXHSXMCBA2
				x.XX ±0.25	CHECK	DATE	SIZE	A4	TITLE:
				x.XXX ±0.15	Andrey		SHEET	2/3	1.27mm Micro I/O 8P Cable Assembly Connector Solder TYPE.Long Push Rod
A0	2022/05/10	NEW RELEASE	Jason	Angle ± 3'	APPROVE	DATE	PROJ.	⌀	Customer NO.
REV	DATE	MODIFICATION DESCRIPTION	CHANGE	DIM	TOL				

**WCON**

Http: [www.wcon.com](http://www.wcon.com)

WCON-Dongguan	WCON-Kunshan
Tel: +86 769 85358920	Tel: +86 512 57468408
Fax: +86 769 85358915	Fax: +86 512 57468468
E-mail: <a href="mailto:sales@wcon.com">sales@wcon.com</a>	E-mail: <a href="mailto:salesks@wcon.com">salesks@wcon.com</a>

# HSF

## Ordering Information

6362-08 M X H SX M C B A 2

Series Code:  
No. of Pins:  
08=8Pin  
Genre:  
M=Male  
Mating Shape:  
See "Table1"  
Type Code:  
H=Solder TYPE

Internal Code:  
2:Long Push Rod  
Packing:  
A=plastic Box  
Color:  
B=Black  
Plastic Cover Material:  
C=ABS+PC  
Metal Cover Material:  
M=SPCC  
Contact Plating:

S4	Sel.15u"Gold/Tin
S5	Sel.30u"Gold/Tin

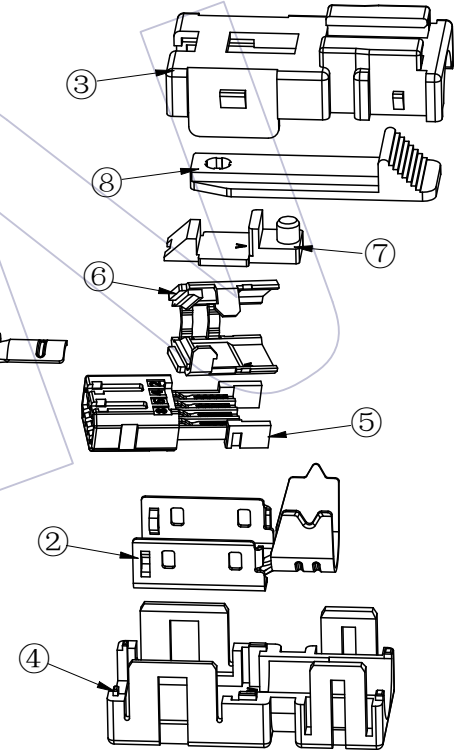
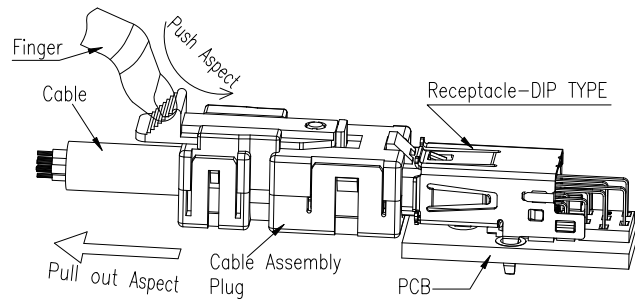
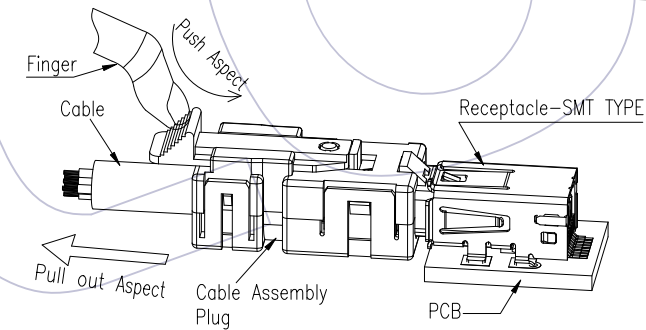
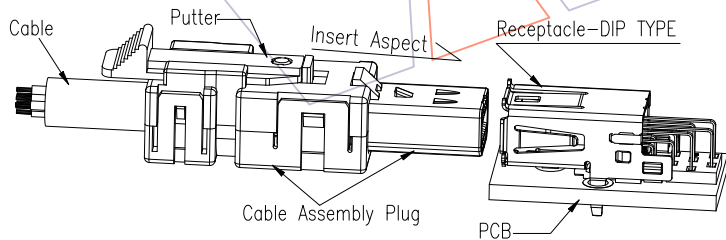
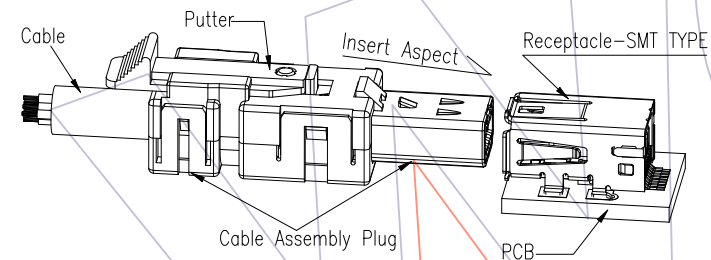

REV	DATE	MODIFICATION DESCRIPTION	CHANGE	OPERATION	DRAW	DATE	SCALE	Fit	PART NO.
A0	2022/05/10	NEW RELEASE	Jason	x.X ±0.40	Jason	2022/05/10	UNIT	mm	6362-08MXHSXMCBA2
				x.XX ±0.25	CHECK	DATE	SIZE	A4	TITLE:
				x.XXX ±0.15	Andrey		SHEET	3/3	1.27mm Micro I/O 8P Cable Assembly Connector Solder TYPE.Long Push Rod
				Angle ± 3°	APPROVE	DATE	PROJ.	⊕	Customer NO.
				DIM TOL					

# WCON

Http: www.wcon.com

WCON-Dongguan	WCON-Kunshan
Tel: +86 769 85358920	Tel: +86 512 57468408
Fax: +86 769 85358915	Fax: +86 512 57468468
E-mail: sales@wcon.com	E-mail: salesks@wcon.com