

# HSF

**NOTES:**

Current Rating: 2.0AMP(All of contacts energized,AT 30°C Rise, 20% Derated)  
 Contact Resistance:20mΩ max  
 Withstand Voltage:1000V AC  
 Insulation Resistance:1000MΩ  
 Operation Temperature:-55°C~+125°C  
 Durability:500 cycling

Terminal Material: Copper Alloy  
 Terminal Plating:(See Ordering Information)  
 XXu" Gold On Contact Area,  
 100U" Tin Min.on Solder area,  
 50U" Nickel Min. Underplating overall.  
 Housing Material:  
 PBT+30%G.F.(UL94V-0),Gray White  
 Ground Strip Material:Copper Alloy

**Ordering Information**

3412 - 3 XX X F P XX X A X

Row Code:  
 3=Three Row

No.of Pins Per Row:  
 10=10Pin  
 16=16Pin  
 32=32Pin  
 40=40Pin

Rows with Contacts:  
 A=a+b+c  
 B=a+b  
 C=a+c  
 D=a

Type Code:  
 F=Female  
 P=Press-fit type

DIP Length:  
 1:L=3.70  
 2:L=4.50

Packing:  
 A=TRAY

Lock:  
 W=W/T Lock  
 N=W/O Lock

Contact Plating:  
 S0: Gold Flash/Tin  
 S1: 3u" Gold/Tin  
 S3: 10u" Gold/Tin  
 S4: 15u" Gold/Tin  
 S5: 30u" Gold/Tin

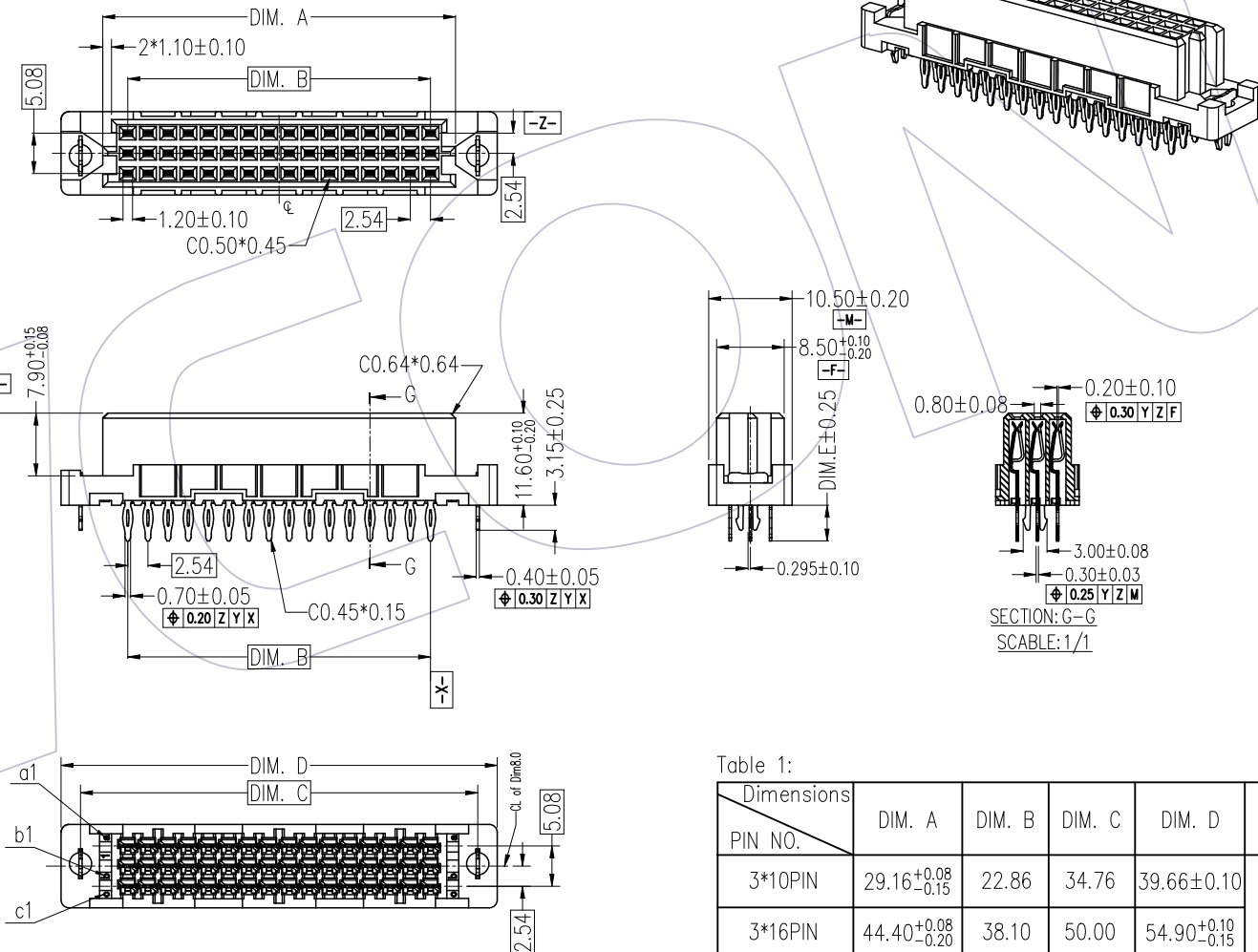

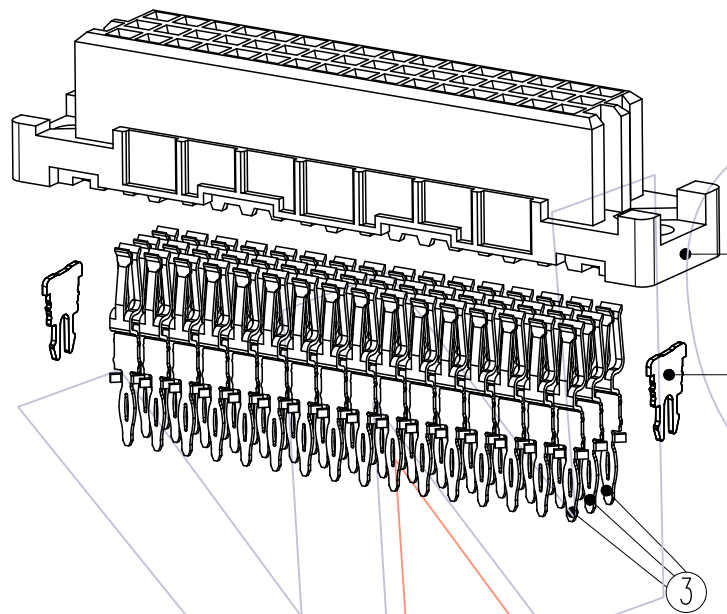

Table 1:

Dimensions	DIM. A	DIM. B	DIM. C	DIM. D	DIM. E
PIN NO.					
3*10PIN	29.16 <sup>+0.08</sup> <sub>-0.15</sub>	22.86	34.76	39.66±0.10	3.7&4.5
3*16PIN	44.40 <sup>+0.08</sup> <sub>-0.20</sub>	38.10	50.00	54.90 <sup>+0.10</sup> <sub>-0.15</sub>	
3*32PIN	85.04 <sup>+0.08</sup> <sub>-0.25</sub>	78.74	90.00	94.90 <sup>+0.10</sup> <sub>-0.20</sub>	
3*40PIN	105.36 <sup>+0.08</sup> <sub>-0.30</sub>	99.06	109.68	115.22 <sup>+0.10</sup> <sub>-0.25</sub>	

		OPERATION		DRAW		DATE		SCALE		FIT		PART NO.		 Http: www.wcon.com	
		X.X	±0.40	Jason		2022/07/16		UNIT	mm			3412-3XXXFPXXXAX			
		X.XX	±0.25	CHECK		DATE		SIZE	A4			TITLE:		WCON-Dongguan	
		X.XXX	±0.15	APPROVE		DATE		SHEET	1/2			3 Row 180' DIP PRESS-FIT TYPE FEMALE		WCON-Kunshan	
A0	2022/07/16	NEW RELEASE		Jason				PROJ.				Customer NO.		Tel: +86 769 85358920	
REV	DATE	MODIFICATION DESCRIPTION		CHANGE								E-mail: sales@wcon.com		Tel: +86 512 57468408	
												E-mail: salesks@wcon.com		Fax: +86 512 57468468	

# HSF





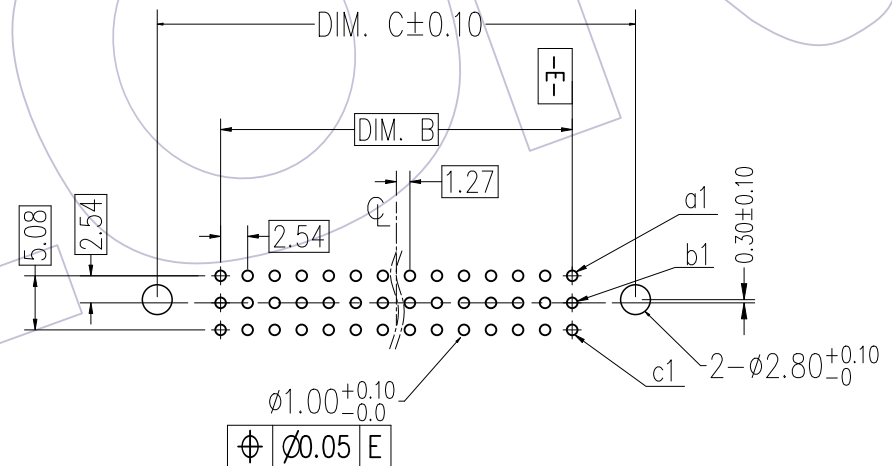

Recommended P.C.B Layout (Top Side)  
(PCB BOARD TOLERANCE  $\pm 0.05$ )



BOM LIST:

ITEM	DESCRIPTION	MATERIALS	NO.	REMARK
①	Housing	PBT(UL94V-0)	1	Gray White
②	Ground strip	Copper Alloy	2	Sn over Ni
③	Terminal	Copper Alloy	Single Row No.of Pin*3	Au Sn over Ni

REV		DATE	MODIFICATION DESCRIPTION	CHANGE	OPERATION		DRAW	DATE	SCALE	FIT	PART NO.		 <a href="http://www.wcon.com">Http: www.wcon.com</a>	
A0		2022/07/16	NEW RELEASE	Jason	X.X	$\pm 0.40$	Jason	2022/07/16	UNIT	mm	3412-3XXXFPXXXAX			
REV		DATE	MODIFICATION DESCRIPTION	CHANGE	X.XX	$\pm 0.25$	CHECK	DATE	SIZE	A4	TITLE:		WCON-Kunshan	
REV		DATE	MODIFICATION DESCRIPTION	CHANGE	X.XXX	$\pm 0.15$	APPROVE	DATE	SHEET	2/2	3 Row 180° DIP PRESS-FIT TYPE FEMALE		Tel: +86 769 85358920	
REV		DATE	MODIFICATION DESCRIPTION	CHANGE	Angle	$\pm 3^\circ$	APPROVE	DATE	PROJ.		Customer NO.		Tel: +86 512 57468408	
REV		DATE	MODIFICATION DESCRIPTION	CHANGE	DIM	TOL	APPROVE	DATE	PROJ.		Customer NO.		Tel: +86 512 57468468	
REV		DATE	MODIFICATION DESCRIPTION	CHANGE	DIM	TOL	APPROVE	DATE	PROJ.		Customer NO.		E-mail: sales@wcon.com	
													E-mail: sales@wcon.com	