

HSF

NOTES:

- 1.No.of Positions:6 Pin
- 2.Rated Current:12.0 A Max;
- 3.Contact Resistance: 20mΩ Max;
- 4.Withstand Voltage: 2000V AC;
- 5.Insulation Resistance:1000MΩ Min ;
- 6.Operation Temperature:-55℃ to +150℃ ;

- 7.Contact Material:Copper Alloy
- 8.Contact Plating:Au or Sn Over Ni
- 9.Insulator Material:High Temperature Thermoplastic(UL94V-0)

Recommended P.C.B Layout(Top Side)
(PCB BOARD TOLERANCE±0.05)

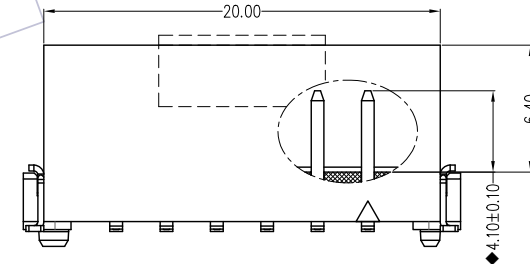
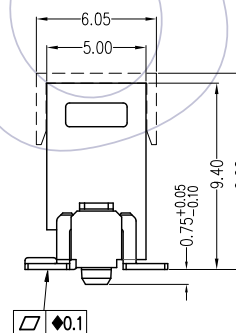
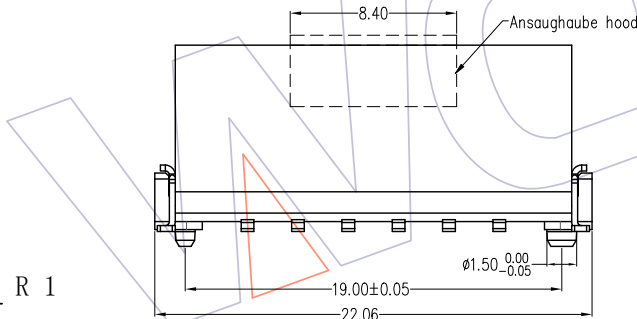
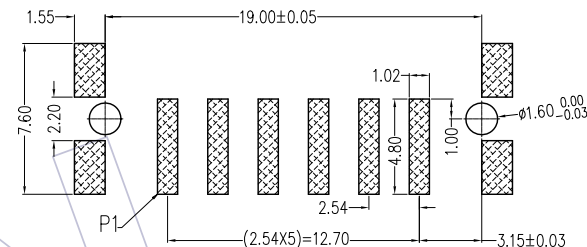
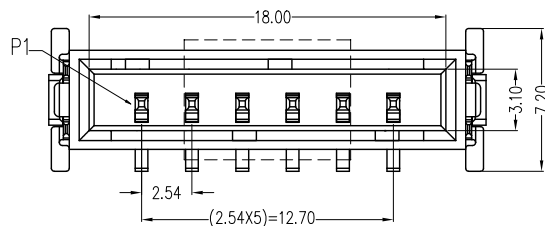

Ordering Information

3915-P 06-1 M XX W D X R 1

Contact Plated:
W3=10u" Gold /Matte Sn
W4=15u" Gold /Matte Sn
W5=30u" Gold /Matte Sn

Color:
B=BLACK
U=BLUE
G=GREEN
R=RED

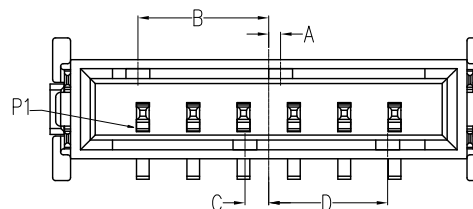

PART NO.	COLOR	防呆尺寸			
		A	B	C	D
3915-P06-1MXXWDBR1	BLACK	0.6	6.6	1.2	6.0
3915-P06-1MXXWDUR1	BLUE	1.8	5.4	2.4	4.8
3915-P06-1MXXWDGR1	GREEN	3.0	4.2	3.6	3.6
3915-P06-1MXXWDRR1	RED	4.2	3.0	4.8	2.4

				OPERATION	DRAW	DATE	SCALE	FIT	PART NO.	 Http: www.wcon.com WCON-Dongguan WCON-Kunshan Tel: +86 769 85358920 Tel: +86 512 57468408 Fax: +86 769 85358915 Fax: +86 512 57468468 E-mail: sales@wcon.com E-mail: salesks@wcon.com
				X.X ±0.40	XSR	2019/12/11	UNIT	mm	3915-P06-1MXXWDXR1	
				X.XX ±0.25	CHECK	DATE	SIZE	A4	TITLE:	
A0	2019/12/11			X.XXX ±0.15	APPROVE	DATE	SHEET	1/1	LSC Connector - Single Row 180°SMT Plug (6 PIN)	
REV	DATE	MODIFICATION	DESCRIPTION	CHANGE			PROJ.		Customer NO.	