

HSF

NOTES:
 Rated Current: 1.0AMP.
 Contact Resistance: 20mΩ Max.
 Withstand Voltage: 500V AC/DC
 Insulation Resistance: 1000MΩ Min.
 Operation Temperature: -40°C to +105°C

Contact Material: Brass
 Contact Plating: Au or Sn Over Ni
 Insulator Material: PA9T+33%G.F UL94V-0 BK

Ordering Information

1320-12 XX XX M XXX C R XX

No. of Pins	Contact Plating	Pin Length	Insulator	Series No.
Per Row: 02-50	G0=Gold Flash G3=10u"Gold G4=15u"Gold G5=30u"Gold S0=Gold Flash/Tin S3=10u"Gold/Tin S4=15u"Gold/Tin S5=30u"Gold/Tin SN=Tin SM=Matte Tin	L=B+D+2.0+ $\frac{W-1.27}{2}$ Standard: 061=6.1 072=7.2 082=8.2	C=PA9T	01-99
				Packing
				A=Tray T=Tube P=Tube+CAP R=Tape&Reel+CAP

Item	Pin Length	W	E	B	Mating
Standard	6.1	5.50	2.50	1.90	2321
	7.2	5.50	2.50	3.00	2334
	8.2	5.50	2.50	4.00	2344
Alternate					

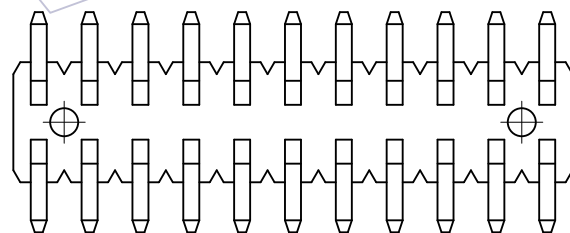
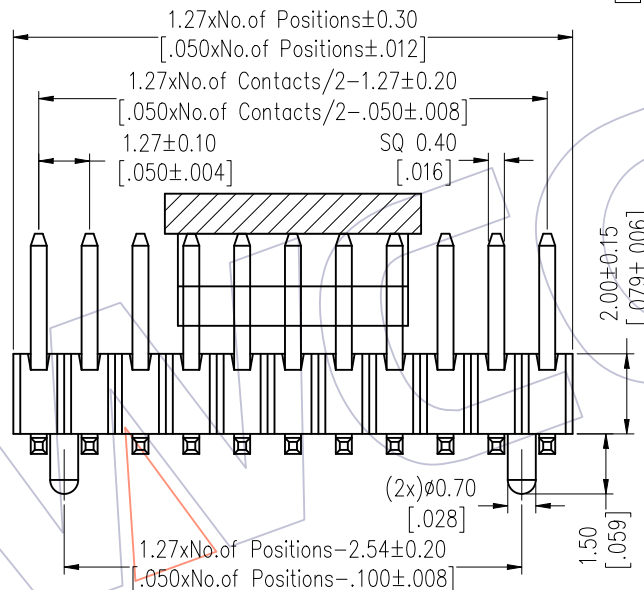
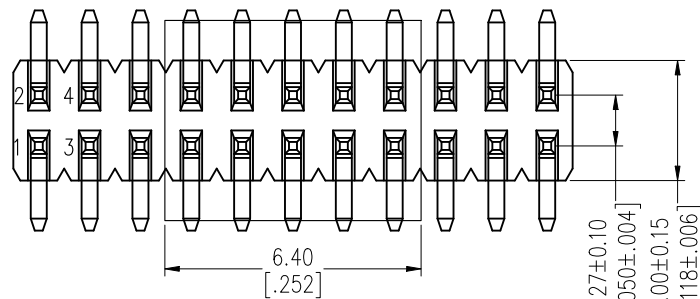

Recommended P.C.B Layout (Top Side)

(PCB BOARD TOLERANCE ±0.05)

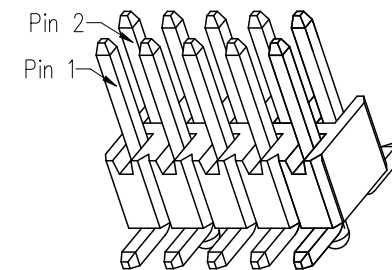
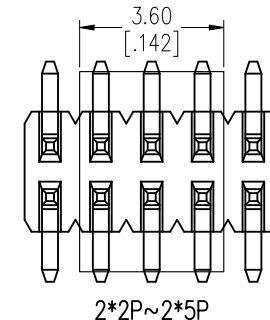
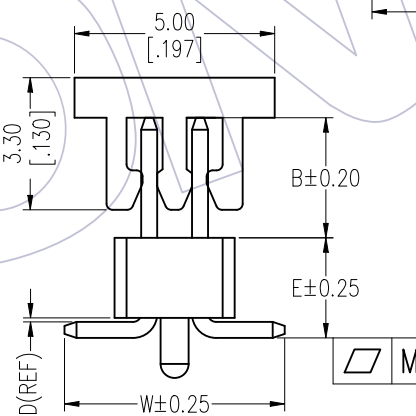
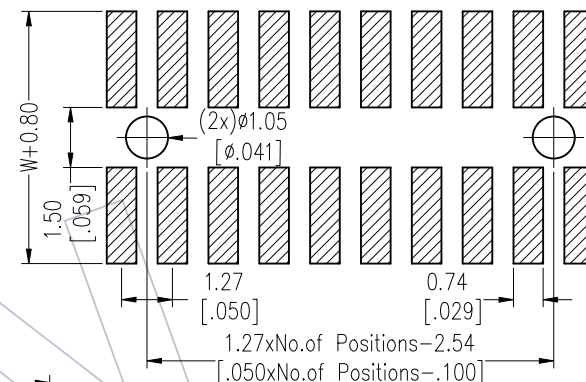

△ A4	PIN	2-15P	16-30P	31-50P
	M	0.10	0.15	0.18

A4	2023/02/02	Add Flatness	△ A4	Du Ying	OPERATION	DRAW	DATE	SCALE	Fit	PART NO.
A3	2021/12/27	MODIFY CAP	△ A3	Du Ying	X.X ±0.40	Du Ying	2023/02/02	UNIT	mm [inch]	1320-12XXXXMXXXCXXX △ A4
A2	2018/01/17	MODIFY PART NO.	△ A2	William Chen	X.XX ±0.25	CHECK	DATE	SIZE	A4	TITLE:
A0	2012/03/22	NEW			X.XXX ±0.15	APPROVE	DATE	SHEET	1/1	1.27 Pin Header, DUAL ROW, SMT, WITH POST, H=2.0
REV	DATE	MODIFICATION DESCRIPTION		CHANGE	Angle ± 3°			PROJ.		Customer NO.
					DIM TOL					

WCON

Http: www.wcon.com

WCON-Dongguan Tel: +86 769 85358920 Fax: +86 769 85358915 E-mail: sales@wcon.com
 WCON-Kunshan Tel: +86 512 57468408 Fax: +86 512 57468468 E-mail: salesks@wcon.com